

ALU-RACK Yamaha FZS 1000

ALU-RACK

Montagehinweise

Alle vom Motorrad gelösten Schrauben sind gemäß Herstellerangaben wieder zu montieren, oder mit von SW-MOTECH gelieferten Schrauben zu ersetzen. Falls nicht anderweitig definiert, diese Schrauben nach Tabelle anziehen.

M6	9,6 Nm
M8	23 Nm
M10	46 Nm

Gegebenenfalls Schrauben mit flüssiger Schraubensicherung einkleben.

Prüfen Sie nach 50 km alle Verbindungen auf festen Sitz.

Max. Zuladung 7,5 Kg inklusive Koffer und Adapter. Ist das Zuladungsgewicht des Fahrzeuges durch den Hersteller limitiert, gelten diese Grenzwerte.

ALU-RACK

Mounting Instructions

SW-MOTECH products should be installed by a qualified, experienced motorcycle technician. If you are unsure of your ability to properly install a product, please have the product installed by your local motorcycle dealer. SW-MOTECH takes no responsibility for damages caused by improper installation.

All screws, bolts and nuts, including all replacement hardware provided by SW-MOTECH, should be tightened to the torque specified in the OEM maintenance manual for your motorcycle. If no torque specifications are provided in the OEM maintenance manual, the following torques may be used:

M6	9,6 Nm
M8	23 Nm
M10	46 Nm







All screws, bolts and nuts should be checked after driving the first 50 km to ensure that all are tightened to the proper torque.

Medium strength liquid thread-locker (i.e., "Locktite") should be used to secure all screws, bolts and nuts.

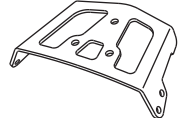
Max. Load On Rear Carrier: 7,5 Kg (16,5 lbs) inclusive case and adapter or the motorcycle manufacturer's weight limit, whichever is less.

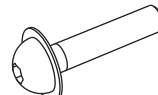
! Achtung: Falls die Montage einer Adapterplatte vorgesehen ist, **MÜSSEN** die Haltenocken am Alu-Rack vor dessen Anbau am Motorrad verschraubt werden.

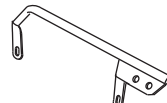
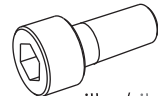
Attention: Cam-locks from adapter kit **MUST** be installed before attaching the alu-rack to the bike.

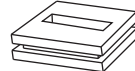
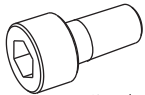
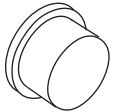
1	ALU-RACK ALU-RACK	2	Distanzbuchse Spacer	3	Linsenschraube Lenshead Screw	4	Mutter mit Bund Locking Nut
							
schwarz/silber		Da:18 Di:8,2 h:24		schwarz/silber		schwarz/black	
GPT.06.238.001		Anzahl/ Pcs. 4		M8 x 45 ISO 7380		M8 DIN 6927	
Anzahl/ Pcs. 1		Anzahl/ Pcs. 4		Anzahl/ Pcs. 4		Anzahl/ Pcs. 4	
5	Haltegriff Handle	6	Zylinderschraube mit Innensechskant Hexagon Socket Screw	7	Distanzbuchse Spacer	8	Verkleidungsgummi Rubber Protection
							
GPT.06.238.910 (L/R)		silber/silber		Da:20 Di:8,2 h:5		KFT.06.095.002	
Anzahl/ Pcs. 2		M8 x 20 DIN 912		Anzahl/ Pcs. 2		Anzahl/ Pcs. 4	
Anzahl/ Pcs. 2		Anzahl/ Pcs. 2		Anzahl/ Pcs. 2		Anzahl/ Pcs. 4	
9	Zylinderschraube mit Innensechskant Hexagon Socket Screw	10	Rohrendkappe Plastic End Cap				
							
silber/silber		KES.RD.150.0200.02.GL					
M8 x 16 DIN 912		Anzahl/ Pcs. 2					
Anzahl/ Pcs. 2		Anzahl/ Pcs. 2					

SW-MOTECH GmbH & Co. KG
Ernteweg 8/10
35282 Rauschenberg
Germany

Tel. +49 (0) 64 25/8 16 8-00
Fax +49 (0) 64 25/8 16 8-10

info@sw-motech.com
www.sw-motech.com

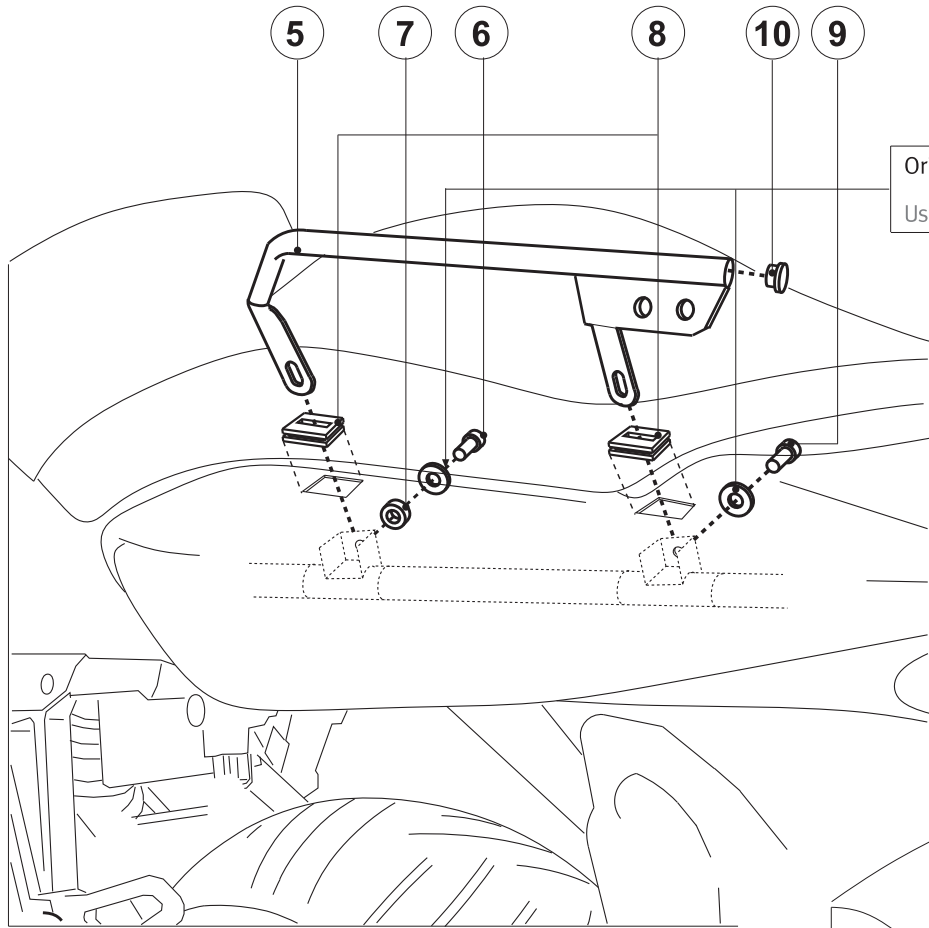

Original Scheibe verwenden
Use original washer

