

Preparation

If the handlebar grips are not open at the end they will need to be cut open for the handguard to be fitted. Use a sharp knife to cut a hole in the end of each handgrip. On the right side the hole size should be neat and no smaller than the inside diameter of the throttle tube. Loosen the throttle assembly to move it outward about 20mm. Roll back the end of the grip and use a hacksaw to carefully cut off the end cap of the plastic throttle tube. Do not remove more than 3mm and take care not to cut the underlying handlebar. Before refitting, remove any burrs that could restrict throttle movement. You can also check our installation video on our Website.

Fitting Procedure

Shown for left side, repeat for right side with applicable parts.

Loosely assemble clamp and saddle (4) to the handlebar next to the mirror/clutch lever bracket. Make sure to leave enough space for clutch and brake switch and looms. **See Image 1.**

Loosely attach the handguard backbone to the handlebar end, spacer/s (9) and bolts (7) & (8) as per diagram.

The preferred backbone position is horizontal or slightly below when viewed from the side.

Tighten all bolts in the following order (7), (8) then (5) and (6) evenly.

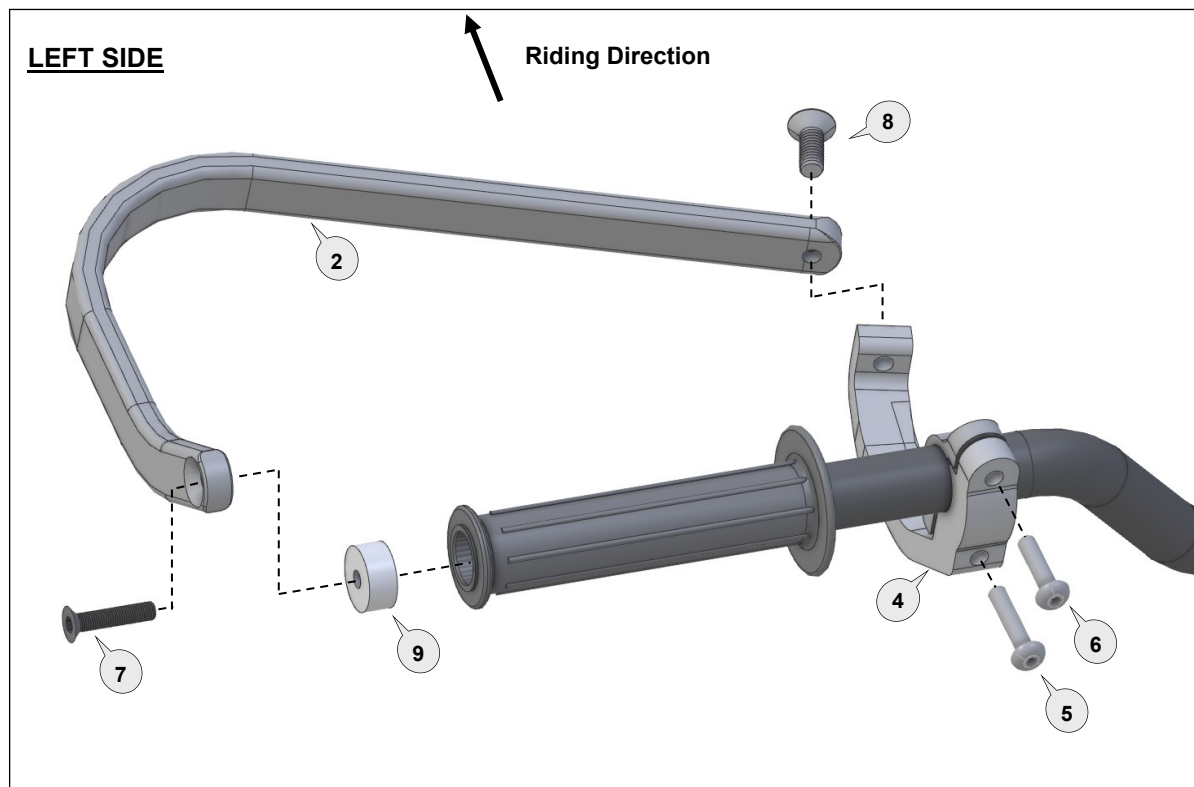
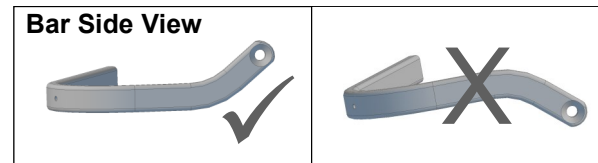
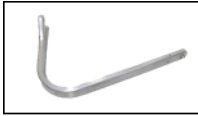
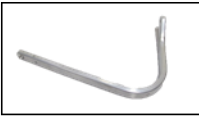

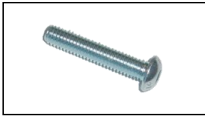

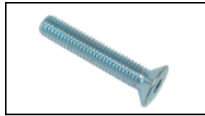



Image 1



← **Clamp location on handlebar**



<p>1 Aluminium Bar - R</p>  <p>PN: BAR-V-036-R Pcs. 1 Right</p>	<p>2 Aluminium Bar - L</p>  <p>PN: BAR-V-036-L Pcs. 1 Left</p>	<p>3 Clamp Frame/Saddle-R</p>  <p>PN: CFS-ADV-R Pcs. 1 Right</p>	<p>4 Clamp Frame/Saddle-L</p>  <p>PN: CFS-ADV-L Pcs. 1 Left</p>	<p>5 Button Head Bolt 30mm</p>  <p>PN: M6X30BHCSZP Pcs. 2</p>	<p>6 Button Head Bolt 20mm</p>  <p>PN: M6X20BHCSZP Pcs. 2</p>	<p>7 Flat Head Bolt 35mm</p>  <p>PN: M6X35FHCSZP Pcs. 2</p>	<p>8 Flat Head Bolt 20mm</p>  <p>PN: M8X20FHCSZP Pcs. 2</p>
---	--	--	--	---	---	---	---

<p>9 Spacer</p>  <p>PN: SP10-22-6 Pcs. 2</p>
--

Personalise Your Protection
Guard options sold separately

	JET-003
	VPS-003
	STM-003
CARBON	BCF-003

Recommended Torque Settings	
M6	10 Nm (7.4 lbf ft)
M8	20 Nm (14.8 lbf ft)

CAUTION:

Installation of the handguard is safety-relevant work and can be complicated. We recommend the installation be performed by a motorcycle service technician. Rideworx accepts no liability for damages caused by improper mounting. All screws, bolts and nuts, including all replacement hardware provided by Rideworx, should be tightened to the torque specified in the table. After the first 50km of riding check all screws, bolts and nuts are tightened to the correct torque. We recommend a medium strength liquid thread lock product on all fasteners.

WARNING:

Check operation of all handlebar controls, specifically the throttle, front brake, kill switch and clutch to ensure they are operating correctly and are in accordance with the OEM specifications. Do not ride the motorcycle if any controls are not operating correctly or if rear view mirror vision is obscured. Check periodically that all bolts are tight.



Email: info@barkbusters.net
Web: www.barkbusters.net



Disclaimer:

A failure to follow these fitting instructions could cause serious injury, death or property damage. These handguards are intended solely for use with motorcycles/ATV/snowmobiles/scooters that have not been modified. They are not designed to prevent injury or death while riding or in an accident or crash. The user must ensure that all controls are free of the handguards every time that they ride. By installing and/or using this product you acknowledge that you accept these terms and have followed the fitting instructions.