

SBL.08.327.100
Revision: 01

KAWASAKI KLE 500

Schutzbügel Montagehinweise

Alle vom Motorrad gelösten Schrauben sind gemäß Herstellerangaben wieder zu montieren, oder mit von SW-MOTECH gelieferten Schrauben zu ersetzen. Falls nicht anderweitig definiert, diese Schrauben nach Tabelle anziehen.

| | |
|-----|--------|
| M6 | 9,6 Nm |
| M8 | 23 Nm |
| M10 | 46 Nm |

Gegebenenfalls Schrauben mit flüssiger Schraubensicherung einkleben.

Prüfen Sie nach 50 km alle Verbindungen auf festen Sitz.

SW-MOTECH GmbH & Co. KG
Ernteweg 8/10
35282 Rauschenberg
Germany

Tel. +49 (0) 64 25/8 16 8-00
Fax +49 (0) 64 25/8 16 8-10

info@sw-motech.com
www.sw-motech.com



Crash Bar Mounting Instructions

SW-MOTECH products should be installed by a qualified, experienced motorcycle technician. If you are unsure of your ability to properly install a product, please have the product installed by your local motorcycle dealer. SW-MOTECH takes no responsibility for damages caused by improper installation.

All screws, bolts and nuts, including all replacement hardware provided by SW-MOTECH, should be tightened to the torque specified in the OEM maintenance manual for your motorcycle. If no torque specifications are provided in the OEM maintenance manual, the following torques may be used:

| | |
|-----|--------|
| M6 | 9,6 Nm |
| M8 | 23 Nm |
| M10 | 46 Nm |

All screws, bolts and nuts should be checked after driving the first 50 km to ensure that all are tightened to the proper torque.

Medium strength liquid thread-locker (i.e., "Loctite") should be used to secure all screws, bolts and nuts.

1 Schutzbügel
Crash Bar

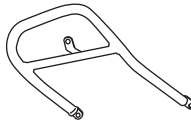

SBL.08.327.901/902
Anzahl/ Pcs. 2 (L/R)

2 Innensechskantschraube
Hexagon Socket Screw

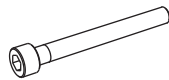

M10 x 300 DIN 912
Anzahl/ Pcs. 1

3 Unterlegscheibe
Washer



A 10,5 DIN 125
Anzahl/ Pcs. 1

4 Mutter mit Bund, selbstsichernd
Lock Nut with Flange



M10 DIN 6927
Anzahl/ Pcs. 1

5 Anbautraverse
Bracket

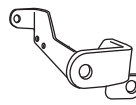

SBL.08.327.001
Anzahl/ Pcs. 1

6 Sechskantschraube
Hexagon Screw

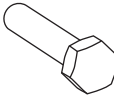

M10 x 1,25 x 35 DIN 961
Anzahl/ Pcs. 1

7 Unterlegscheibe
Washer



A 10,5 DIN 125
Anzahl/ Pcs. 1

8 Bügelschraube
Bowscrew

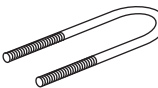

BUS.00.08.043.068.01
Anzahl/ Pcs. 1

9 Mutter mit Bund, selbstsichernd
Lock Nut with Flange

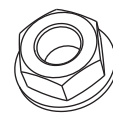

M8 DIN 6927/b
Anzahl/ Pcs. 2

10 Innensechskantschraube
Hexagon Socket Screw

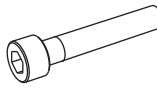

M8 x 25 DIN 912
Anzahl/ Pcs. 2

11 Unterlegscheibe
Washer



A 8,4 DIN 125
Anzahl/ Pcs. 2

12 Mutter mit Bund, selbstsichernd
Lock Nut with Flange



M8 DIN 6927/b
Anzahl/ Pcs. 2

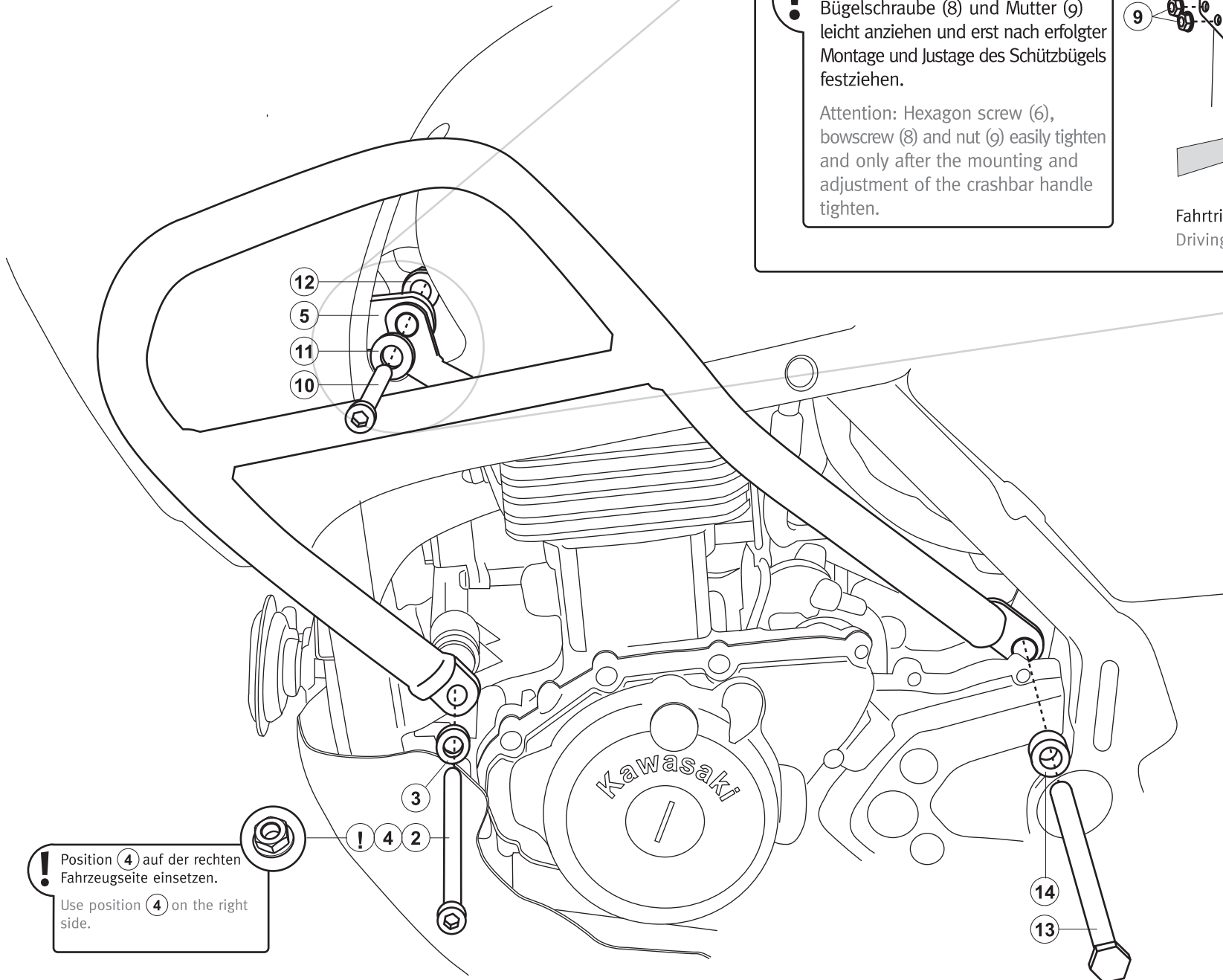

! Achtung: Sechskantschraube (6),
Bügelschraube (8) und Mutter (9)
leicht anziehen und erst nach erfolgter
Montage und Justage des Schützbügels
festziehen.

Attention: Hexagon screw (6),
bowscrew (8) and nut (9) easily tighten
and only after the mounting and
adjustment of the crashbar handle
tighten.

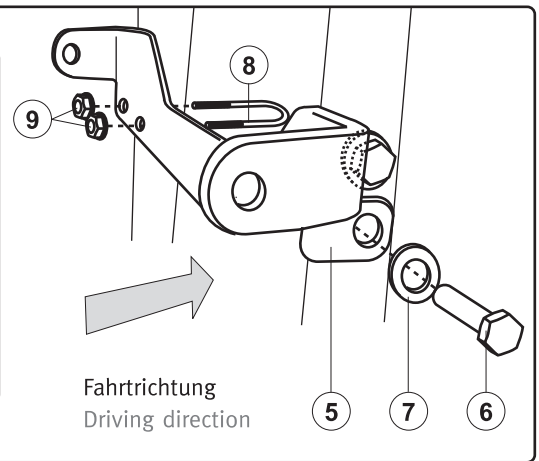

! Position (4) auf der rechten
Fahrzeugseite einsetzen.
Use position (4) on the right
side.

13 Sechskantschraube
Hexagon Screw

M10 x 180 DIN 931

Anzahl/ Pcs. 1

14 Distanzbuchse
Spacer

Da:20 Di:10,5 h:6

Anzahl/ Pcs. 1

←
Fahrtrichtung
Driving direction