

ALU-RACK YAMAHA TDM 900
ALU-RACK YAMAHA TDM 900

Montagehinweise

Alle vom Motorrad gelösten Schrauben sind gemäß Herstellerangaben wieder zu montieren, oder mit von SW-MOTECH gelieferten Schrauben zu ersetzen. Falls nicht anderweitig definiert, diese Schrauben nach Tabelle anziehen.

M5	5,5 Nm
M8	23 Nm

Gegebenenfalls Schrauben mit flüssiger Schraubensicherung einkleben.

Prüfen Sie nach 50 km alle Verbindungen auf festen Sitz.

**Max. Zuladung 12 Kg inklusive Koffer und Adapter.
Ist das Zuladungsgewicht des Fahrzeuges durch den Hersteller limitiert, gelten diese Grenzwerte.**

Mounting Instruction

SW-MOTECH products should be installed by a qualified, experienced motorcycle technician. If you are unsure of your ability to properly install a product, please have the product installed by your local motorcycle dealer. SW-MOTECH takes no responsibility for damages caused by improper installation.

All screws, bolts and nuts, including all replacement hardware provided by SW-MOTECH, should be tightened to the torque specified in the OEM maintenance manual for your motorcycle. If no torque specifications are provided in the OEM maintenance manual, the following torques may be used:

M5	5,5 Nm
M8	23 Nm

All screws, bolts and nuts should be checked after driving the first 50 km to ensure that all are tightened to the proper torque.







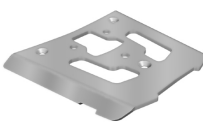

Medium strength liquid thread-locker (i.e., "Loctite") should be used to secure all screws, bolts and nuts.

Max. Load On Rear Carrier: 12 Kg (26 lbs) inclusive case and adapter or the motorcycle manufacturer's weight limit, whichever is less.

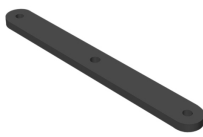
SW-MOTECH GmbH & Co. KG
Ernteweg 8/10
35282 Rauschenberg
Germany

Tel. +49 (0) 64 25/8 16 8-00
Fax +49 (0) 64 25/8 16 8-10

info@sw-motech.com
www.sw-motech.com

<p>1 ALU-RACK ALU-RACK</p>  <p>schwarz/silber GPT.06.235.001 Anzahl/ Pcs. 1</p>	<p>2 Senkkopfschraube Counter Sunk Screw</p>  <p>silber/silber M8 x 80 DIN 7991 Anzahl/ Pcs. 2</p>	<p>6 Unterbau Base Bracket</p>  <p>GPT.06.235.003 Anzahl/ Pcs. 1</p>
<p>3 Distanzbuchse Spacer</p>  <p>Da:20 Di:8,4 h:35 Anzahl/ Pcs. 2</p>	<p>7 Sechskantschraube Hexagon Screw</p>  <p>silber/silber M5 x 25 DIN 933 Anzahl/ Pcs. 2</p>	<p>8 Unterlegscheibe Washer</p>  <p>silber/silber A 5,3 DIN 125 Anzahl/ Pcs. 2</p>
<p>4 Senkkopfschraube Counter Sunk Screw</p>  <p>silber/silber M8 x 55 DIN 7991 Anzahl/ Pcs. 1</p>	<p>5 Distanzbuchse Spacer</p>  <p>Da:20 Di:8,4 h:43 Anzahl/ Pcs. 1</p>	<p>9 Distanzbuchse Spacer</p>  <p>Da:12 Di:5,3 h:10 Anzahl/ Pcs. 2</p>

! Achtung: Falls die Montage einer Adapterplatte vorgesehen ist, MÜSSEN die Haltenocken am ALU-RACK vor dessen Anbau am Motorrad verschraubt werden.

Attention: Cam-locks from adapter kit MUST be installed before attaching the ALU-RACK to the bike.

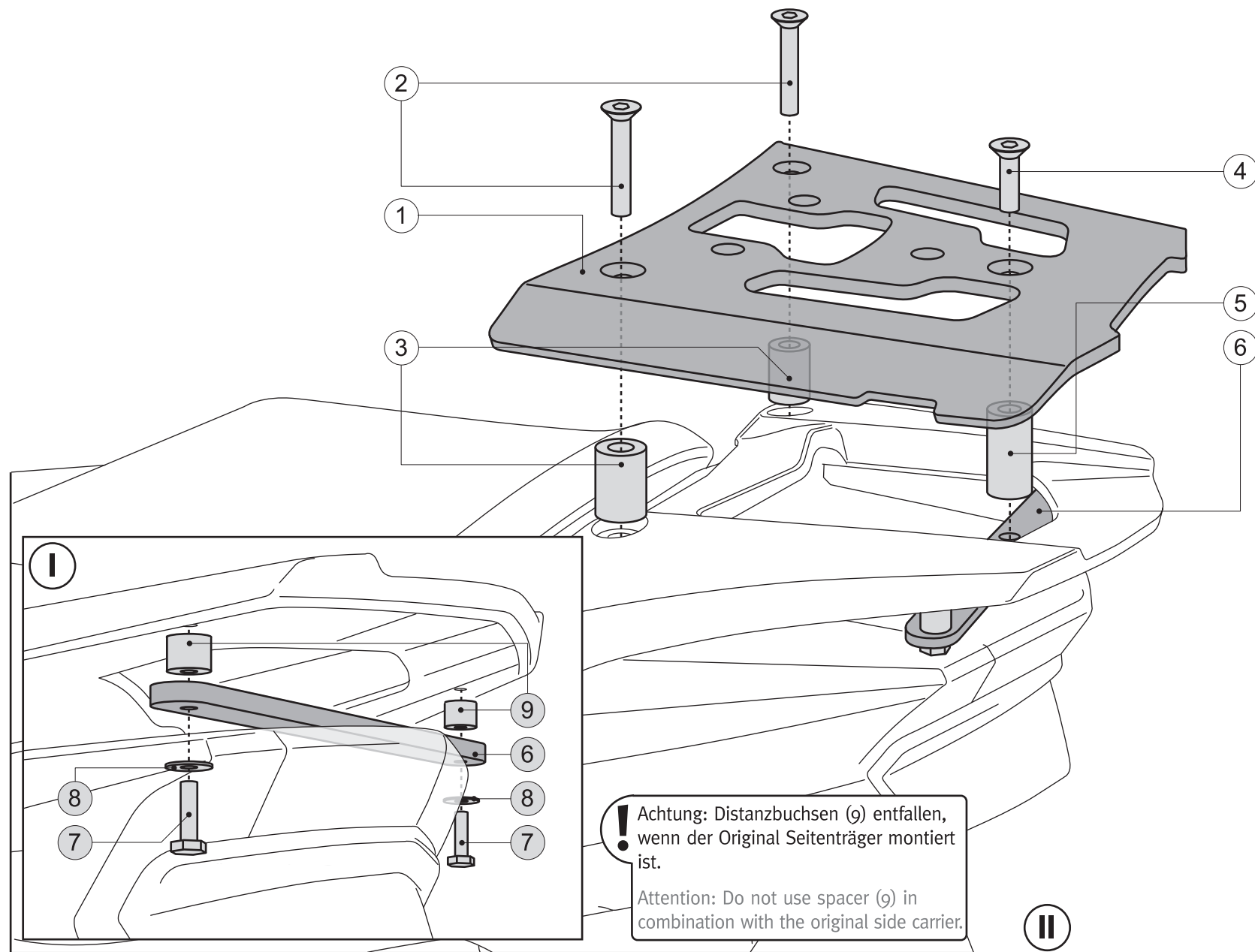

! Achtung: Distanzbuchsen (9) entfallen, wenn der Original Seitenträger montiert ist.

Attention: Do not use spacer (9) in combination with the original side carrier.

II