

Preparation

Remove original handlebar end weights and handguards if installed.

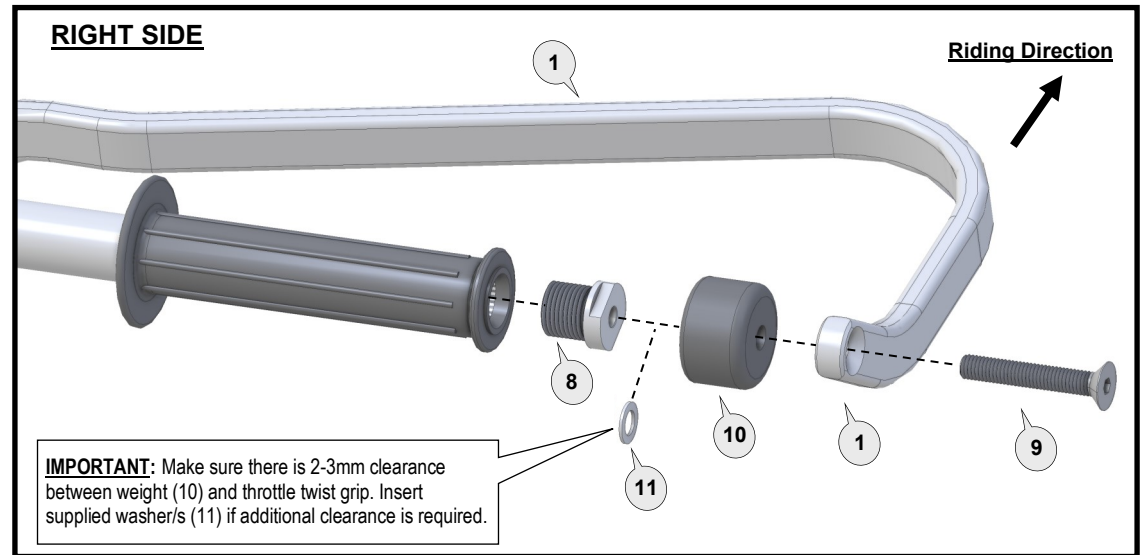
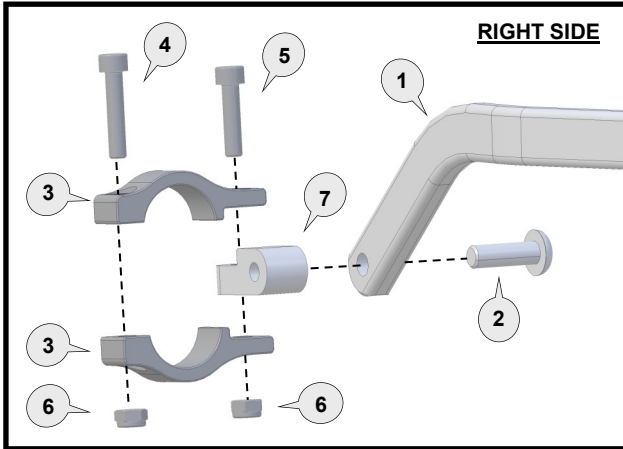

Important Fitting Procedure

Note: Handguard clamps are to be fitted next to the handlebar mount. See image to right. Loosely assemble the clamp (3) to the handlebar, as per diagram above, taking note of the orientation of the clamp connector (7).

Fit Threaded Insert (8) into handlebar end and tighten to specified torque setting. Attach the handguard backbone with applicable parts to the handlebar end and also to the clamp connector (7).

Position backbone so it is horizontal when viewed from the side and tighten bolt (9).

The clamp bolts must be tightened in the following order:

Tighten bolt (2) through the aluminium bar (1) to clamp connector (7) of the clamp assembly.

Tighten bolt (5) to solidly lock the clamp connector (7) between the clamp saddles (3).

Tighten bolt (4) to secure the clamp assembly firmly to the handlebar.

Note: The clamp is designed to allow the nut on bolt (5) to pull into the recessed hole. This eliminates the need for a wrench after the bolt starts to tighten.

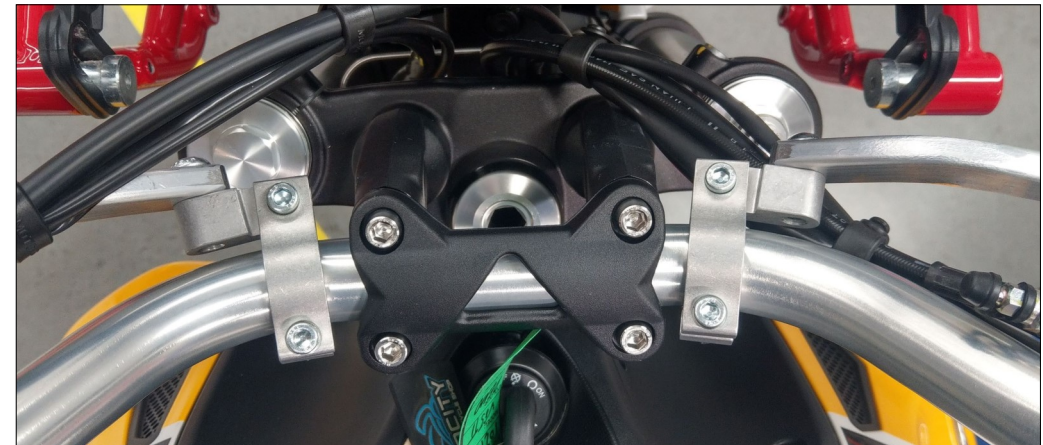

Bar Side View

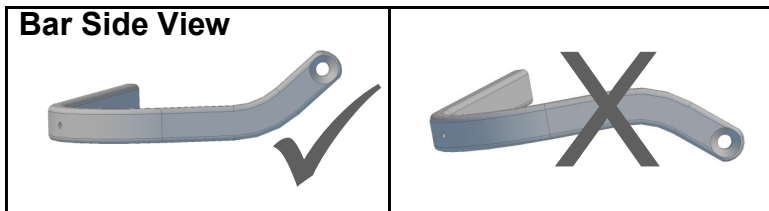







Personalise Your Protection

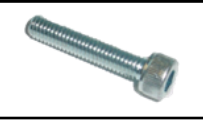

Guard options sold separately

| | |
|---------------|---------|
| JET | JET-003 |
| VPS | VPS-003 |
| Storm | STM-003 |
| CARBON | BCF-003 |

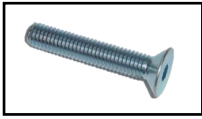
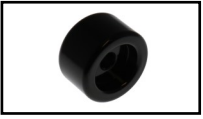

Phone: +61 (0)2 4271 8244
Email: info@barkbusters.net

| | | | | | | | |
|--|---|---|--|---|---|--|---|
| <p>1 Aluminium Bar</p>  <p>PN: BAR-V-054 Pcs. 1 Left & 1 Right</p> | <p>2 Button Head Bolt 25mm</p>  <p>PN: M8X25BHCSZP Pcs. 2</p> | <p>3 Clamp Saddle</p>  <p>PN: CS-00 Pcs. 4 pieces</p> | <p>4 Socket Head Bolt 30mm</p>  <p>PN: M6X30SHCSZP Pcs. 2</p> | <p>5 Socket Head Bolt 25mm</p>  <p>PN: M6X25SHCSZP Pcs. 2</p> | <p>6 Nylock Nut 6mm</p>  <p>PN: M6LN Pcs. 4</p> | <p>7 Clamp Connector</p>  <p>PN: CP6-V4 Pcs. 2</p> | <p>8 Bar End Fitting</p>  <p>PN: BESF4 Pcs. 2</p> |
|--|---|---|--|---|---|--|---|

| | | |
|---|---|---|
| <p>9 Flat Head Bolt 45mm</p>  <p>PN: M8X45FHCSZP Pcs. 2</p> | <p>10 Bar End Weight</p>  <p>PN: BEW35 Pcs. 2</p> | <p>11 Washer</p>  <p>PN: M8FW-SS Pcs. 2</p> |
|---|---|---|

| Recommended Torque Settings | |
|-----------------------------|---------------------|
| M6 | 10 Nm (7.4 lbf ft) |
| M8 | 20 Nm (14.8 lbf ft) |
| M18 (item 8) | 21Nm (15.5 lbf ft) |

CAUTION:

Installation of the handguard is safety-relevant work and can be complicated. We recommend the installation be performed by a motorcycle service technician. Rideworx accepts no liability for damages caused by improper mounting. All screws, bolts and nuts, including all replacement hardware provided by Rideworx, should be tightened to the torque specified in the below table. After the first 50km of riding check all screws, bolts and nuts are tightened to the correct torque. We recommend a medium strength liquid thread lock product on all fasteners.

WARNING:

It is important there is a working clearance (approx 3mm) between the throttle grip end and the handguard to ensure a free closing throttle. Check operation of all handlebar controls, specifically the throttle, front brake, kill switch and clutch to ensure they are operating correctly and are in accordance with the OEM specifications. Do not ride the motorcycle if any controls are not operating correctly. Check periodically that all bolts are tight.



Email: info@barkbusters.net
Web: www.barkbusters.net



Disclaimer:

A failure to follow these fitting instructions could cause serious injury, death or property damage. These handguards are intended solely for use with motorcycles/ATV/snowmobiles/scooters that have not been modified. They are not designed to prevent injury or death while riding or in an accident or crash. The user must ensure that all controls are free of the handguards every time that they ride. By installing and/or using this product you acknowledge that you accept these terms and have followed the fitting instructions.